

Driver LCO 75W 200–1050mA 107V cS NF C SNC essence NFC outdoor series



Product description

- _ Dimmable 75 W built-in constant current LED-Driver for basic, functional Streetlighting luminaires
- _ For luminaires of protection class I and protection class II
- _ Temperature protection as per EN 61347-2-13 C5e
- _ In line with industry standards (high surge/burst, NFC programming, high Power Factor, long life-time)
- _ Output current adjustable between 200 – 1,050 mA via NFC (pre-selected current 200 mA)
- _ Autonomous dimming via driver in-built chronoSTEP functionality
- _ Nominal lifetime up to 100,000 h
- _ Wide operating window
- _ 5 years guarantee + 3 years of warranty extension depending on operating conditions (conditions at <https://www.tridonic.com/en/int/services/manufacturer-guarantee-conditions>)

Interfaces

- _ NFC for programming and configuration (single and multi packaging)
- _ chronoSTEP3 V2 (astronomical midnight) for fixed reduction of the luminous flux in the night
- _ u6Me2 for centrally programming the streetlights via mains from the cabinet
- _ Terminal blocks: 45° push terminals

Functions

- _ Adjustable output current in 1-mA-steps (NFC)
- _ Programmable chronoSTEP: times and levels (NFC, U6Me2) – 1 profile programmable
- _ Constant light output function (CLO)
- _ Protective features
- _ Intelligent Voltage Guard Plus (IVG+)

Benefits

- _ Wide operating window (1 output) to cover different LED module combinations and several operating points of the luminaire
- _ NFC programming and current adjustment for easy configuration
- _ chronoSTEP drivers to be programmed "centrally" in the field from the cabinet via U6Me2
- _ High surge protection: up to 10 kV
- _ Integrated ESD protection

Typical applications

- _ Street- and Roadlighting, in line with European Street Lighting Standard EN-13201

Website

<http://www.tridonic.com/87501192>



Linear



High bay



Decorative



Downlights



Spotlights



Free-standing



Area



Floor | Wall



Street

Driver LCO 75W 200–1050mA 107V cS NF C SNC

essence NFC outdoor series

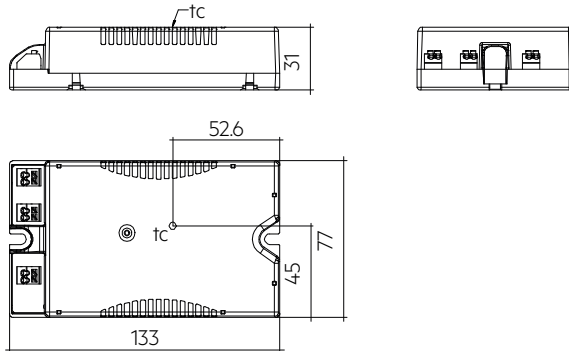
**Ordering data**

Type	Article number	Packaging, carton	Packaging, pallet	Weight per pc.
LCO 75/200-1050/107 cS NF C SNC	87501192	20 pc(s).	240 pc(s).	0.257 kg

Technical data

Rated supply voltage	220 – 240 V
AC voltage range	198 – 264 V
Mains frequency	50 / 60 Hz
Overvoltage protection	320 V AC, 48 h
Typ. rated current (at 230 V, 50 Hz, full load) ^{①②}	360 mA
Leakage current (at 230 V, 50 Hz, full load) ^{①②}	< 700 μ A
Touch current (equipotential connected) ^③	550 μ A
Max. input power	82.5 W
Output power range (P _{rated})	5.6 – 75 W
Typ. efficiency (at 230 V, 50 Hz, full load) ^{②④}	91 %
λ over full operating range (max.)	0.98
λ over full operating range (min.)	0.5C
In-rush current (peak / duration)	30.25 A / 266 μ s
THD (at 230 V, 50 Hz, full load)	< 10 %
Starting time (AC mode)	< 500 ms
Turn off time (at 230 V, 50 Hz, full load)	< 500 ms
Output current tolerance ^{①⑤}	\pm 5 %
Max. output current peak (non-repetitive)	\leq output current + 15 %
Output LF current ripple (< 120 Hz)	\pm 5 %
Output P _{ST_LM} (at full load)	\leq 1
Output SVM (at full load)	\leq 0.4
Max. output voltage (U-OUT)	140 V
Dimming range	10 – 100 % (min. 100 mA)
Mains surge capability (between L - N) ^⑥	6 kV
Mains surge capability (between L/N - PE) ^⑦	10 kV
Surge voltage at output side (against PE)	< 1 kV
Type of protection	IP20
Lifetime	up to 100,000 h
Guarantee (conditions at www.tridonic.com)	5 Year(s)
Dimensions L x W x H	133 x 77 x 31 mm

Approval marks**Standards**

EN 55015, EN 61000-3-2, EN 61000-3-3, EN 61000-4-4, EN 61000-4-5, EN 61347-1, EN 61347-2-13, EN 62384, EN 61547

Specific technical data

Type	Article number	Output current	Min. output voltage	Max. output voltage	Max. output power	Typ. power consumption (at 230 V, 50 Hz, full load)	Typ. current consumption (at 230 V, 50 Hz, full load)	t _c point max.	Ambient temperature t _a
LCO 75/200-1050/107 cS NF C SNC	87501192	200 mA	28 V	107.0 V	21.4 W	24.7 W	116 mA	75 °C	-40 ... +65 °C
LCO 75/200-1050/107 cS NF C SNC	87501192	300 mA	28 V	107.0 V	32.1 W	35.7 W	165 mA	75 °C	-40 ... +65 °C
LCO 75/200-1050/107 cS NF C SNC	87501192	400 mA	28 V	107.0 V	42.8 W	47.0 W	210 mA	75 °C	-40 ... +65 °C
LCO 75/200-1050/107 cS NF C SNC	87501192	500 mA	28 V	107.0 V	53.5 W	58.5 W	260 mA	75 °C	-40 ... +65 °C
LCO 75/200-1050/107 cS NF C SNC	87501192	600 mA	28 V	107.0 V	64.2 W	69.5 W	307 mA	78 °C	-40 ... +60 °C
LCO 75/200-1050/107 cS NF C SNC	87501192	700 mA	28 V	107.0 V	74.9 W	81.4 W	360 mA	78 °C	-40 ... +60 °C
LCO 75/200-1050/107 cS NF C SNC	87501192	800 mA	28 V	93.8 V	75.0 W	81.5 W	360 mA	78 °C	-40 ... +60 °C
LCO 75/200-1050/107 cS NF C SNC	87501192	900 mA	28 V	83.4 V	75.1 W	81.7 W	361 mA	78 °C	-40 ... +55 °C
LCO 75/200-1050/107 cS NF C SNC	87501192	1,050 mA	28 V	71.4 V	75.0 W	82.5 W	363 mA	78 °C	-40 ... +55 °C

① Valid at 100 % dimming level.

② Depending on the selected output current.

③ Maximum of "perception and reaction" and "let go" values according to EN 60598-1.

④ Tolerance range ± 5 %.

⑤ Output current is mean value.

⑥ L-N acc. to EN 61000-4-5. 2 Ohm, 1,2/50 μs, 8/20 μs.

⑦ 10 kV acc. to EN 61547, 8 kV acc. to EN 61000-4-5.

1. Standards

EN 55015
 EN 61000-3-2
 EN 61000-3-3
 EN 61000-4-4
 EN 61000-4-5
 EN 61347-1
 EN 61347-2-13
 EN 62384
 EN 61547

1.1 Glow wire test

according to EN 61347-1 with increased temperature of 850 °C passed.

1.2 Light modulation

according to IEC 1789 device fulfils "no observable effect level".

2. Thermal details and lifetime

2.1 Expected lifetime

Expected lifetime								
Type	Output current	ta	40 °C	45 °C	50 °C	55 °C	60 °C	65 °C
LCO 75/200-1050/107 cS NF C SNC	200 – 500 mA	tc	55 °C	59 °C	63 °C	67 °C	70 °C	75 °C
		Lifetime	> 100,000 h	> 100,000 h	> 100,000 h	80,000 h	57,000 h	44,000 h
	>500 – 800 mA	tc	60 °C	65 °C	70 °C	75 °C	78 °C	–
		Lifetime	> 100,000 h	> 100,000 h	74,000 h	56,000 h	42,000 h	–
>800 – 1050 mA	tc	65 °C	70 °C	75 °C	78 °C	–	–	
	Lifetime	> 100,000 h	94,000 h	75,000 h	52,000 h	–	–	

The LED driver is designed for a lifetime stated above under reference conditions and with a failure probability of less than 10 %.

The relation of tc to ta temperature depends also on the luminaire design.

If the measured tc temperature is approx. 5 K below tc max., ta temperature should be checked and eventually critical components (e.g. ELCAP) measured. Detailed information on request.

3. Installation / wiring

3.1 Circuit diagram

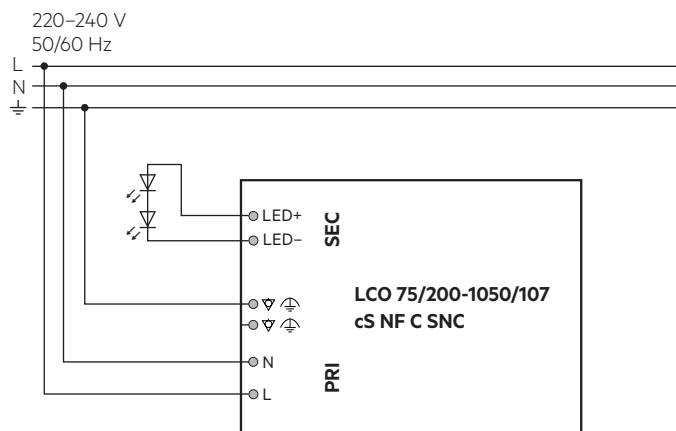

Both earth terminals have the same function and can be used interchangeably. (Through wiring not supported)

3.2 Wiring type and cross section

Input/Output side:

For wiring use solid or stranded wire from 0.2 – 1.5 mm².

Strip 8.5 – 9.5 mm of insulation from the cables to ensure perfect operation of terminals.

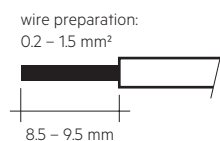

3.3 Wiring guidelines

- Run the secondary lines separately from the mains connections and lines to achieve good EMC performance.
- The max. secondary cable length (LED) is 2 m (4 m circuit).
- For good EMC performance, keep the LED wiring as short as possible.
- Secondary switching is not permitted.
- The LED driver has no inverse-polarity protection on the secondary side. Wrong polarity can damage LED modules with no inverse-polarity protection.
- Wrong wiring of the LED driver can lead to malfunction or irreparable damage.
- To avoid damage of the Driver, the wiring must be protected against short circuits to earth (sharp edged metal parts, metal cable clips, louver, etc.).

3.4 Hot plug-in

Hot plug-in is not supported due to residual output voltage of > 0 V.

When connecting an LED load, restart the device to activate the LED output.

This can be done via mains reset.

3.5 Earth connection

The earth connection is conducted as function earth (FE). There is no earth connection required for the functionality of the LED driver. Earth connection is recommended to improve following behaviour:

- Electromagnetic interferences (EMI)
- Transmission of mains transients to the LED output

3.6 Installation note

Max. torque at the clamping screw: 0.5 Nm / M4

4. Electrical values

4.1 Operating window

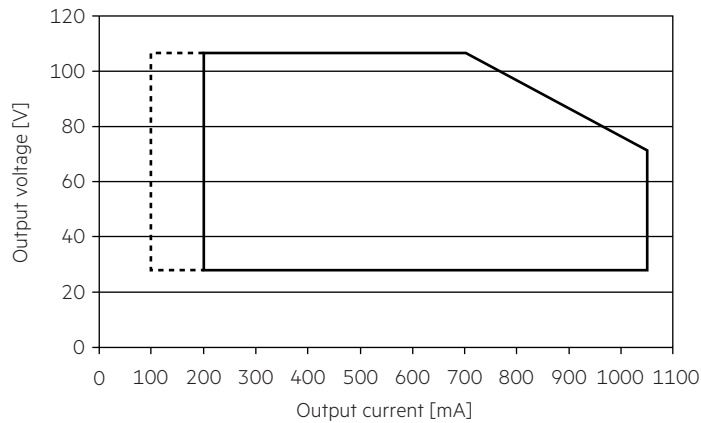

- Operating window
- - - - - dimming in chronoSTEP

Make sure that the LED driver is operated within the given window under all operating conditions. Special attention needs to be paid at dimming as the forward voltage of the connected LED modules varies with the dimming level, due to the implemented amplitude dimming technology. Coming below the specified minimum output voltage of the LED driver may cause the device to shut-down.

4.2 Efficiency vs load

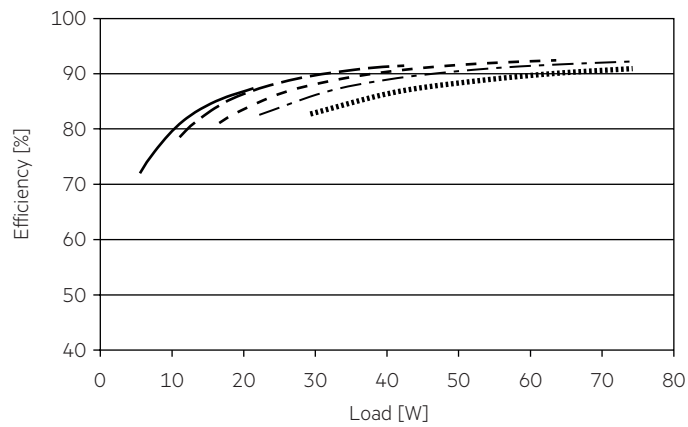

- 200 mA
- - - 400 mA
- . - . 600 mA
- - - - 800 mA
- 1050 mA

4.3 Power factor vs load

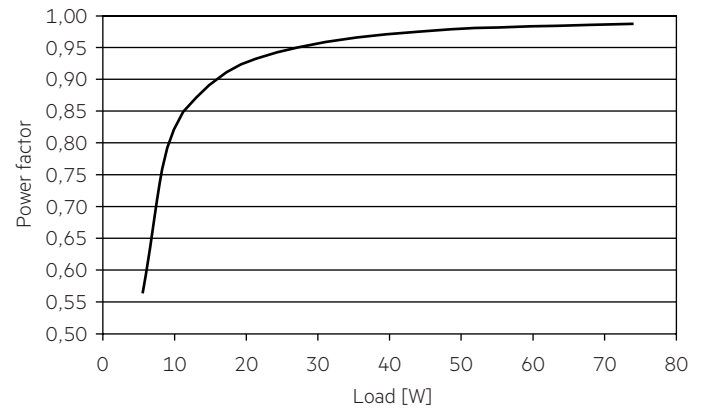

4.4 THD vs load

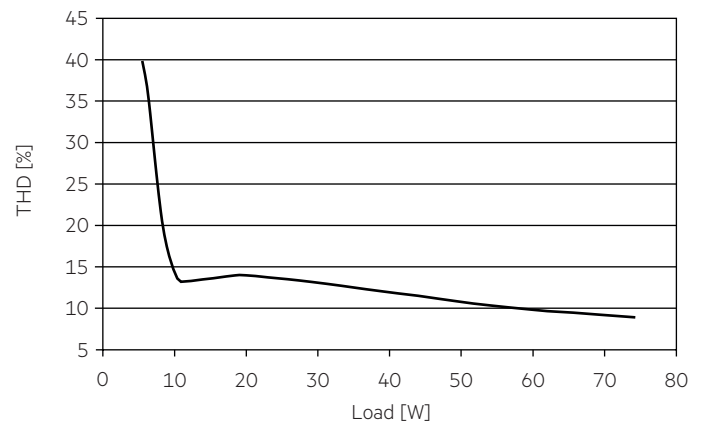

100 % load corresponds to the max. output power (full load) according to the table "Specific technical data".

4.5 Maximum loading of automatic circuit breakers in relation to inrush current

Automatic circuit breaker type	C10	C13	C16	C20	B10	B13	B16	B20	Inrush current	
Installation Ø	1.5 mm ²	1.5 mm ²	2.5 mm ²	4 mm ²	1.5 mm ²	1.5 mm ²	2.5 mm ²	4 mm ²	I_{max}	time
LCO 75/200-1050/107 cS NF C SNC	16	23	28	35	10	14	17	21	30.25 A	266 µs

These are max. values calculated out of inrush current! Please consider not to exceed the maximum rated continuous current of the circuit breaker.

Calculation uses typical values from ABB series S200 as a reference.

Actual values may differ due to used circuit breaker types and installation environment.

4.6 Harmonic distortion in the mains supply (at 230 V / 50 Hz and full load) in %

	THD	3.	5.	7.	9.	11.
LCO 75/200-1050/107 cS NF C SNC	< 10	< 10	< 10	< 7	< 5	< 3

5. Software / Programming / Interfaces

5.1 Software / programming

With appropriate software and interface different functions can be activated and various parameters can be configured in the LED driver.

The Driver supports the following software and interfaces:

Software / hardware for configuration:

- companionSUITE (deviceGENERATOR, deviceCONFIGURATOR, deviceANALYSER)

Interfaces for data transfer:

- NFC
- U6Me2

5.2 Nearfield communication (NFC)

The NFC Interface allows wireless communication with the LED driver.

This interface offers the option to write configuration and to read configuration, errors and events with the companionSUITE.

A correct communication between the LED driver and the NFC antenna can only be guaranteed if the antenna is placed directly on the Driver.

Any material placed between the LED driver and the NFC antenna can cause a deterioration of the communication quality.

After programming the device via NFC power up the device one time for one second till the deviceANALYSER can read out the parameters.

We recommend the use of following NFC antenna:

www.tridonic.com/nfc-readers

NFC is complied with ISO/IEC 15693 standard.

Changing parameters via NFC shall be done by qualified engineers only.

5.3 U6Me2

Settings of chronoSTEP function could be done via switching mains commands.

For detailed description for timings and intervals see product manual.

Key features:

- Auto-dimming with 1 sequence
- Every sequence can hold 8 parameter pairs
- Separate dim-level for each time parameter
- Various commands + parameter for extensions

It is not necessary to select the operating mode of the device, as the only operating mode is chronoSTEP.







chronoSTEP can be switched off using the switch in the GUI.

6. Functions

☉ companionSUITE:

NFC

The companionSUITE with deviceGENERATOR, deviceCONFIGURATOR and deviceANALYSER is available via our WEB page:
<https://www.tridonic.com/com/en/products/companionsuite.asp>

Icon	Function	NFC	U6Me2
	OEM Identification	☉	-
	OEM GTIN	☉	-
	LED current	☉	-
	chronoSTEP	☉	☉
	Constant light output (CLO)	☉	-
	Factory reset	☉	-
	deviceKEY	☉	-

6.1 OEM Identification

The OEM (Original Equipment Manufacturer) can set his own identification number.

6.2 OEM GTIN

The Original Equipment Manufacturer (OEM) can set his own Global Trade Item Number (GTIN).

6.3 LED current

The LED output current must be adapted to the connected LED module. The value is limited by the current range of the respective device.

6.4 chronoSTEP (Virtual Midnight)

In the outdoor lighting and street lighting sector it often makes sense to dim the lighting level during night hours in order to save energy. The chronoSTEP function is a tool that makes this easy to do. The device automatically measures the switch-on and switch-off times of the lighting installation over the past three days. The switch-on and switch-off times are typically the times at which the sun sets and rises. The midpoint of these two reference points is the time referred to as Virtual Midnight. The overall time interval between switch-on and switch-off points is called On Time.

Notice

Only support one profile programmed by customer. When calculating the On-Time, only values between 4 and 24 hours are counted. Values less than 4 hours could indicate a power failure and are therefore not saved. For settings longer than 24 hours, 24 hours is saved as the maximum possible value.

6.5 Constant Light Output (CLO)

With this function the light output of the LED module can be kept equal over the lifetime.

The light output of an LED module reduces over the course of its lifetime. The Constant Light Output (CLO) function compensates for this natural decline by constantly increasing the output current of the LED driver throughout its lifetime.

CLO shall be achieved by limitation of the LED current at the commissioning of the LED driver and providing a linear interpolation of the current over the time, depending on the data points given by the user.

6.6 Factory reset

This device supports the function to reset all parameters back to factory defaults.

6.7 deviceKEY

This function enables a password protection for device settings to prevent unauthorized access or changes.

7. Protective features

7.1 Overtemperature protection

The controlgear is protected against temporary thermal overheating. If the temperature limit is exceeded the controlgear will switch off. It restarts automatically.

The temperature protection is activated typically 10 °C above T_c max.

7.2 Short-circuit behaviour

In case of a short circuit on the output side(LED) the controlgear switches off. After elimination of the short-circuit fault controlgear will not recover automatically. Need restart

7.3 No-load operation

The converter will trigger OVP protection and then output voltage change to 0V which allows the application to be able to work safely when LED string opens due to a failure.

7.4 IVG+ – Intelligent Voltage Guard Plus



In some cases mains voltage is not stabilized and has some voltage peaks which are lower or higher than the nominal voltage range.

Between 192 V and 150 V input voltage, the LED driver operates in under-voltage mode and dims the secondary side linearly down to 100 mA.

Below 140 V input voltage, the LED driver shuts down, restarts at 150 V (without a reset) and dims linearly up back to 100 %. Above 280 V input voltage, the LED driver shuts down. If input voltage drops below 270 V, the LED driver restarts (without a reset).

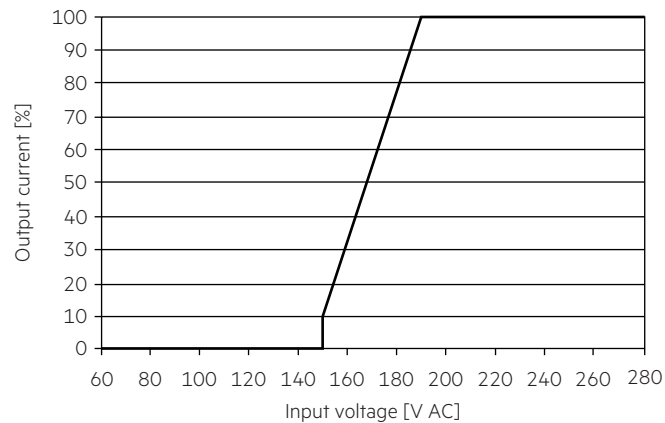

7.5 Insulation between terminals

Insulation	Mains	LED	FE
Mains	–	double	double
LED	double	–	double
FE	double	double	–

basic ... represents basic insulation.

double ... represents double or reinforced insulation.

7.6 ESD protection

The potential risk of electrostatic discharge (ESD) during certain weather conditions (like dry air and wind) and using the drivers in an installation on non-conductive poles is avoided.

8. Miscellaneous

8.1 Insulation and electric strength testing of luminaires

Electronic devices can be damaged by high voltage. This has to be considered during the routine testing of the luminaires in production.

According to IEC 60598-1 Annex Q (informative only!) or ENEC 303-Annex A, each luminaire should be submitted to an insulation test with 500 V_{DC} for 1 second. This test voltage should be connected between the interconnected phase and neutral terminals and the earth terminal.

The insulation resistance must be at least 2 MΩ.

As an alternative, IEC 60598-1 Annex Q describes a test of the electrical strength with 1500 V_{AC} (or 1.414 x 1500 V_{DC}). To avoid damage to the electronic devices this test must not be conducted.

The equipotential terminal is used to connect the heat sink and the LED driver to reduce transients.

8.2 Conditions of storage and use

Humidity: 5% up to max. 95%, not condensed

Storage temperature: -40 °C up to max. +80 °C

The devices have to be acclimatised to the specified temperature range (t_a) before they can be operated.

The LED driver is declared as inbuilt LED controlgear, meaning it is intended to be used within a luminaire enclosure.

If the product is used outside a luminaire, the installation must provide suitable protection for people and environment (e.g. in illuminated ceilings).

8.3 Maximum number of switching cycles

All LED driver are tested with 50,000 switching cycles.

The actually achieved number of switching cycles is significantly higher.

8.4 Additional information

Additional technical information at www.tridonic.com → Technical Data

Lifetime declarations are informative and represent no warranty claim.

No warranty if device was opened.